

# Setup Instructions

## ASAP Flat Display



### GENERAL INFORMATION

Thank you for choosing ASAP!

For additional information please feel free to call us at 877-977-5537 or visit our website at [www.asapcanopy.com](http://www.asapcanopy.com)

Our office hours are weekdays 9:00 AM to 6:00 PM EST. If you need assistance over the weekend, please email [support@info@asapcanopy.com](mailto:support@info@asapcanopy.com) and one of our staff members will respond as soon as possible.

### TOOLS

No tools required

### PARTS

(A) 4x long straight poles



(B) 1x slim straight support pole



(C) 4x corner poles:  
2x curved  
2x straight



(D) 2x single edge feet

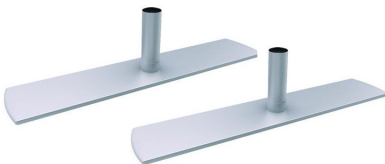

(E) 1x fabric graphic

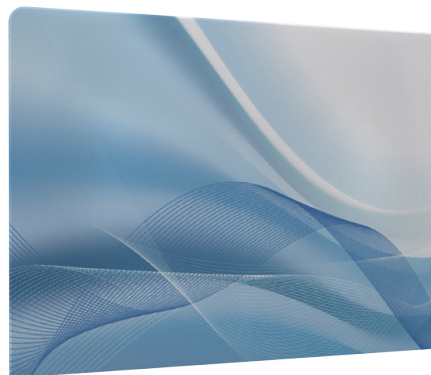

**STEP 01**

Assemble straight poles (A, B).

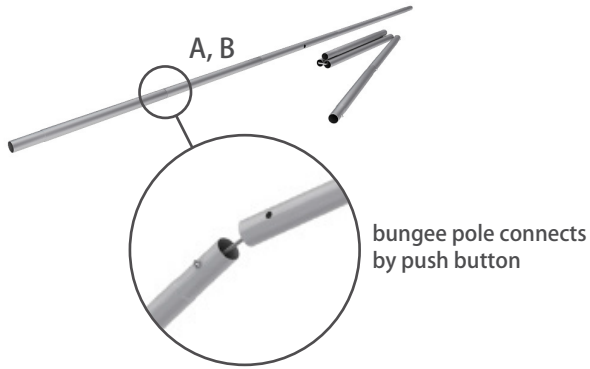

**STEP 02**

Connect corner poles (B) to straight poles (A) with matching shape codes (connects by push button).

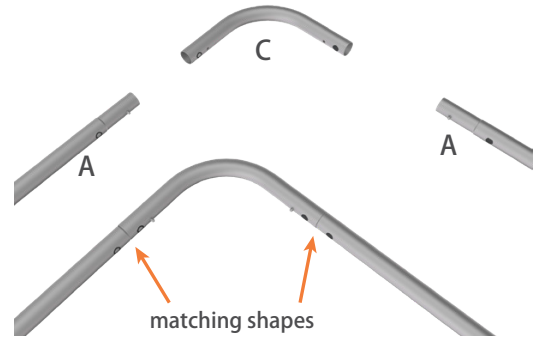

**STEP 03**

Insert straight support pole (B) in center of long straight poles (A).

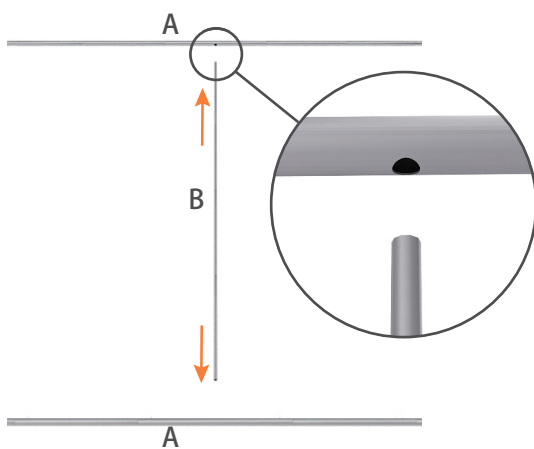

**STEP 04**

Frame layout.

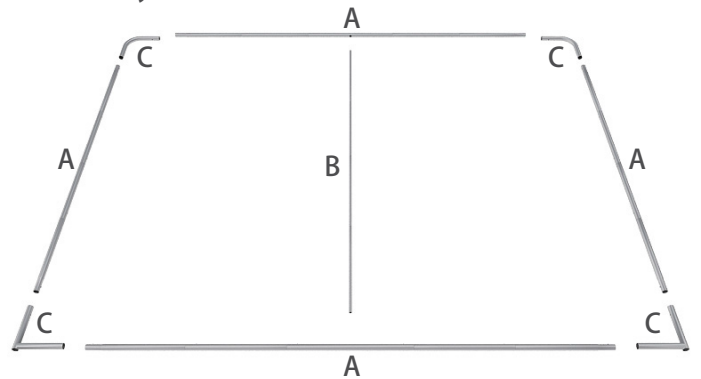

**STEP 05**

Connect feet (D) by pressing and pushing.

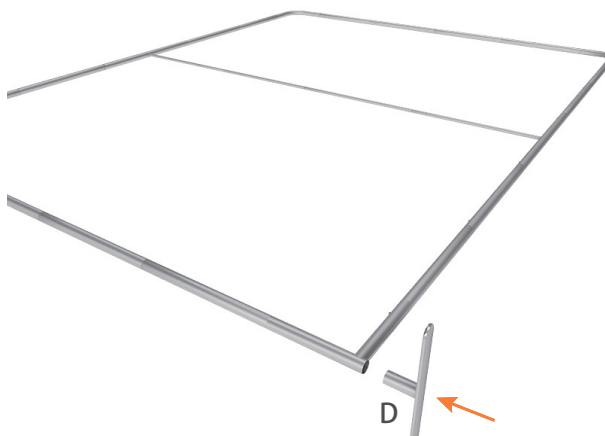

**STEP 06**

Unzip fabric graphic (E) and lay image face down. Slide fabric onto frame like a pillow case.

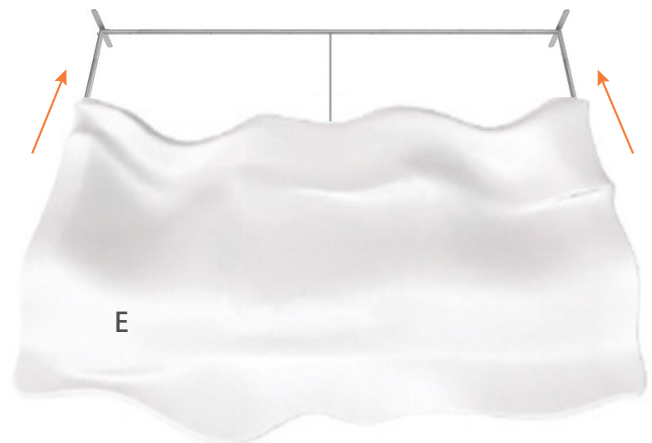

**STEP 07**

Zip the edge of graphic beyond the center support pole as shown. This will hold the center support pole in place. Zip the remaining side and bottom to meet at the corner.

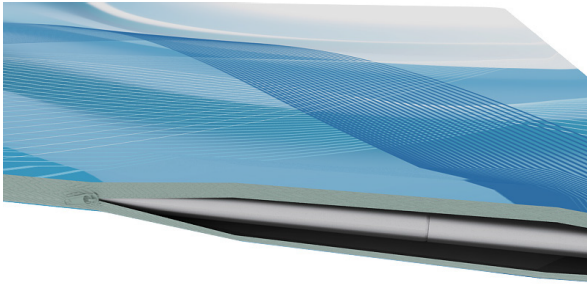

**STEP 08 (OPTIONAL)**

To straighten your Waveline frame, grasp one side of the frame with two hands and carefully twist the frame in the opposite direction of the lean. Repeat on each side until the frame is standing straight.

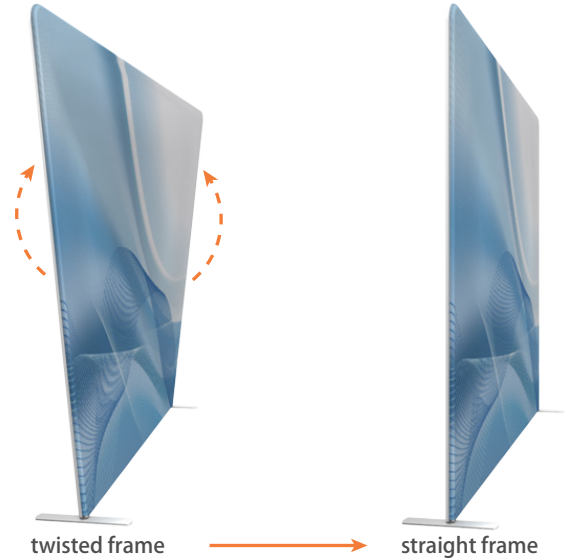

**STEP 09 (OPTIONAL)**

Position lights as desired and tighten knob to hold in place. **WARNING!** Over tightening may cause damage to fabric image on frame.

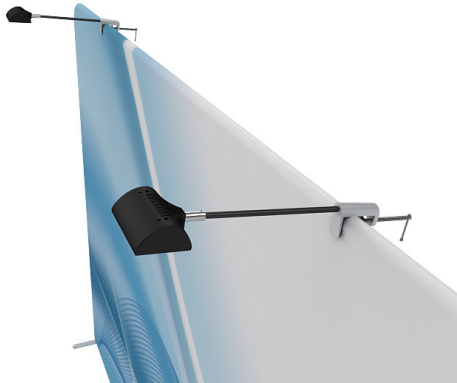

**STEP 10**

Complete.

